

Chapter 1 Safety Requirement and Cautions

To ensure safety of your health, equipment and property, please read this chapter carefully before using the frequency inverter and act in compliance with the instructions when installing, debugging, running and overhauling the frequency inverter.

1.1 Safety Definition

Danger: it will cause danger of serious injuries and even death while operating against the rules.

Caution: it will cause danger of light injuries or equipment destruction while operating against the rules.

Note: some information is useful while operating and use frequency inverter.

1.2 Safety Requirements and Cautions

●Before Installation

Danger
1. Only qualified personnel can operate the equipment. Before operating, be sure to carefully read the manual about safety, installation, operation and maintenance. The safe operation depends on the proper processes of choosing models, carrying, installation, operation and maintenance.

Danger
1. Don't use the damaged or incomplete frequency inverters; Otherwise, there is risk of injury.

●Installation

Danger
1. Please install the frequency inverter on metal or other nonflammable material, and keep it away from the combustible material. Otherwise there is danger of fire;
2. No unauthorized modification to the frequency inverter; Otherwise there is danger of damaged.
3. Normal frequency inverter, which is not explosion-proof, can not be installed where with explosive gas or dust; Otherwise there is danger of explosion.

Attention
1. When two frequency inverters are installed in the same control cabinet, please pay attention to the installing place to guarantee the effective heat dissipation.
2. When carrying the frequency inverter, please support its bottom.

●Wiring

Danger
1. Wire is connected only when the main circuit is cut off, otherwise there is a danger of shock.
2. Wire is connected by professional person only. Otherwise there is a danger of shock.
3. Earth must be reliable. Otherwise there is a danger of shock.
4. AC power supply should not be connected with output ports U, V, W, otherwise there is a danger of damage to frequency

inverter.

5. No drop of bolt, spacer, metal stick, conducting wire or other things into the inner of frequency inverter; Otherwise there is a danger of fire or damage to frequency inverter.

Attention

1. If the damage to frequency inverter or other equipment is caused by improper wiring and utilization or unauthorized alteration, the user should shoulder all responsibilities.
2. Please make sure all wirings meet EMC requirement and satisfy safety standard in the local area; Please refer to recommendations in this manual or national standards of wire diameter to avoid accidents.
3. Static electricity on human body would seriously damage internal MOS transistor, etc. No touch the printed circuit boards, IGBT or other internal devices without anti-static measure, otherwise it will cause the malfunction of frequency inverter.
4. Please don't connect phase shifter capacitance or LC/RC noise filter to the output circuit of frequency inverter; Otherwise it will damage the frequency inverter.
5. Please don't connect the magnetic switch or magnetic contactor to the output circuit of frequency inverter; When frequency inverter is in the operation with load, magnetic switch or magnetic contactor can make inverter over-current protection function act. It will damage frequency inverter seriously.
6. Please don't disassemble the panel cover, it only needs to disassemble the terminal cover when wiring.
7. It is forbidden to do any pressure test on frequency inverter, otherwise it will damage the frequency inverter.

●Before Electrification

Danger

1. Please make sure that voltage grade of power supply is consistent with frequency inverter's voltage and then check whether the wiring is correct and firm, and whether there is short circuit in peripheral equipment's circuit. Otherwise it will damage frequency inverter and other equipment.
2. Before the frequency inverter is connected to the input power supply, make sure that the cover has been well fixed. Otherwise it will cause electric shock.
3. For the frequency inverters whose storage time is over 1 year, when electrification, the voltage should be raised by booster from low to high. Otherwise it will damage the frequency inverter.

Attention

1. Check if all periphery fittings are wired properly according to the handbook; Otherwise it will cause accidents.

●After Electrification

Danger

1. After electrified, it is forbidden to open the cover, make wiring, and check up; Otherwise, it will cause the danger of electric shock.
2. After electrified, it is forbidden to contact internal wiring board and its parts. Otherwise it will cause the danger of electric shock.
3. Do not operate or touch frequency inverter with wet hand. Otherwise there is danger of damage to frequency inverter and electric shock.

Attention

1. Please set the parameter of frequency inverter cautiously; Otherwise it will damage equipment.

●Operation**Danger**

1. Before running, please check and confirm the application range of the machine and equipment once more; Otherwise it will cause accidents.
2. Please don't touch the cooling fan and braking resistance to check the temperature; Otherwise there is a danger of getting burn.
3. Unprofessional workers are banned to check the signals in the running stage; Otherwise it will cause injuries and damage the equipment.

Attention

1. Please don't turn off the equipment by switching off power; Please cut off the power supply after the electric machine stops running; Otherwise it will damage the frequency inverter.
2. Please avoid anything dropping into the equipment when the frequency inverter is running; Otherwise it will cause electric shock.

●Maintenance**Danger**

1. Please don't maintain and repair the equipment with electric; Otherwise it will cause electric shock.
2. Before maintaining and repairing the frequency inverter, please make sure the indicator lights of power supply have completely turned off; Otherwise it may cause electric shock and damage the frequency inverter.
3. Persons who have not passed specialized train are not allowed to conduct the frequency inverter maintenance; Otherwise it may cause electric shock and damage the frequency inverter.

1.3 Cautions in Using

1. In application of this series frequency inverter, you have to confirm all machine insulation to prevent damage to the equipment. Moreover, when the motor working in tough environment, please periodic inspect the electrical insulation to ensure the safety of the system work.
2. If the motor adapter is not consistent with frequency inverter's rating current (The rating current of the motor is far smaller than that of frequency inverter), please adjust the protective value to ensure safe running.
3. In occasions such as load raises, usually there is negative torque and frequency inverter breaks off for over-current or over-voltage. In this case, you should consider choosing the matching brake unit.
4. Frequency inverter, in a certain output frequency range, can meet the mechanical resonance of the load equipment. To avoid it, you can set up jumping frequency.
5. As output voltage of the inverter is pulse-wave type, if there is capacity which can improve power factor or pressure-sensitive resistance which used for thunder-proof in the voltage output side, the frequency inverter will break off or its parts will be damaged, so it is necessary to dismantle them. Moreover, it is proposed not install switch parts like air switch and contactor (if it is necessary to install switch on output side, please make sure the output electricity of frequency

inverter is zero when the switch is working)

6. At over 1,000 meters altitude, the inverter's heat dissipation function worsened due to the thin air, it is necessary to use less.
7. The inverter output voltage is pulse wave type. If using digital multi-meter measurement, deviation of the reading will be great. And the deviation is different by using different type of digital multi-meter. Under normal circumstances, while RMS 380V, digital multi-meter reading is around 450V.
8. Solar panel can be connected in the series or parallel. For rated voltage 380V controller, we suggest working voltage between 480V and 560V while MPPT. What means the solar panel open circuit voltage should be between 600V and 700V.

1.4 Technical Specification

Solar pump inverter power(KW)	Pump		Max solar power input (KW)	Max DC input voltage V	Recommend Voc voltage (V)	Rated output current (A)	Output frequency (Hz)
	Rated power (KW)	Rated voltage (V)					
SI23-D1 series, DC60-400VDC input, 3 phase 110-230VAC output							
0.75	0.75	110	1.0	400	175~380	7A	0-600
1.5	1.5	110	1.95	400	175~380	10A	0-600
SI23-D3 series,DC150V-450V input, 3 phase 220-240VAC output							
0.75	0.75	220	1.0	450	360~430	4A	0-600
1.5	1.5	220	1.95	450	360~430	7A	0-600
2.2	2.2	220	2.86	450	360~430	10A	0-600
4	4	220	5.4	450	360~430	16A	0-600
SI23-D5 series,DC250V to 780VDC input, 3 phase 380-460VAC output							
0.75	0.75	380	1.0	780	620~750	3.0	0-600
1.5	1.5	380	2.2	780	620~750	4.0	0-600
2.2	2.2	380	3.3	780	620~750	6.0	0-600
4	4	380	5.6	780	620~750	10	0-600
5.5	5.5	380	8	780	620~750	13	0-600
7.5	7.5	380	10	780	620~750	17	0-600
11	11	380	14.3	780	620~750	25	0-600
15	15	380	19.5	780	620~750	32	0-600
18.5	18.5	380	23.4	780	620~750	38	0-600
22	22	380	28.6	780	620~750	45	0-600
30	30	380	39	780	620~750	60	0-600
SI23-T3 series,DC350V to 780VDC input,3phase 380-440VAC output							
37	37	380	48.1	780	620~750	75	0-600
45	45	380	58.5	780	620~750	90	0-600
55	55	380	71.5	780	620~750	110	0-600
75	75	380	97.5	780	620~750	150	0-600

1.5 Cautions in Disposal

When you dispose frequency inverter, please pay attention to:

1. Electrolytic capacitor: the electrolytic capacitor of main circuit or the printing plate may explode when they are burned.
2. Plastic: plastic incineration may generate toxic gases.
3. Dispose method: please dispose as industrial waste.

Chapter 2 Installation and Wiring

2.1 Dimension of Inverter

Overall Dimension of Inverter (Plastic)

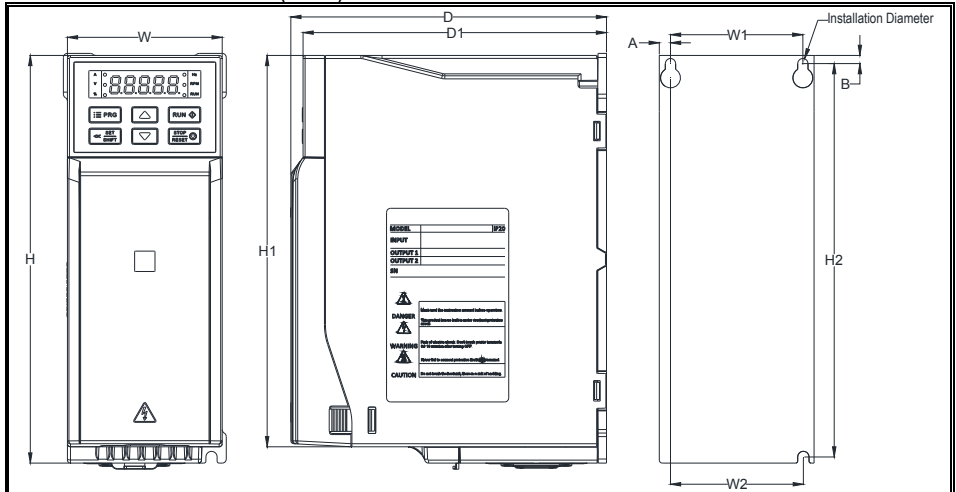

MODEL	Overall Dimension(mm)					Installation Dimension(mm)					Aperture
	W	H	H1	D	D1	W1	W2	H2	A	B	
SI23-D3-R75G	76	200	192	155	149	65	65	193	5.5	4	φ3-M4
SI23-D3-1R5G											
SI23-D3-2R2G	100	242	231	155	149	84	86.5	231.5	8	5.5	φ3-M4
SI23-D3-004G											
SI23-D5-R75G	76	200	192	155	149	65	65	193	5.5	4	φ3-M4
SI23-D5-1R5G											
SI23-D5-2R2G											
SI23-D5-004G	100	242	231	155	149	84	86.5	231.5	8	5.5	φ3-M4
SI23-D5-5R5G											
SI23-D5-7R5G	116	320	307.5	175	169	98	100	307.5	9	6	φ3-M5
SI23-D5-011G											

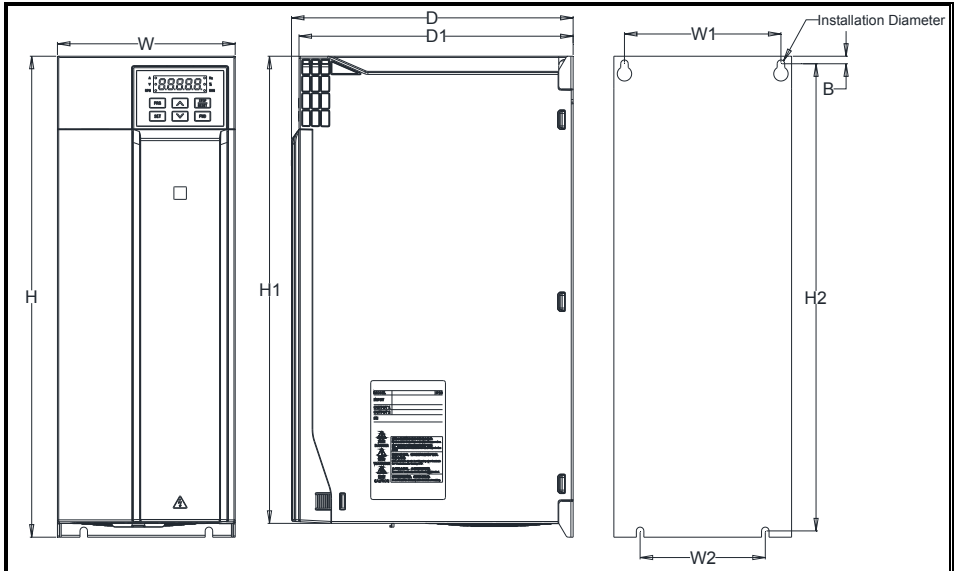

MODEL	Overall Dimension(mm)					Installation Dimension(mm)				Aperture
	W	H	H1	D	D1	W1	W2	H2	B	
SI23-D5-015G	142	383	372	225	219	125	100	372	6	φ4-M5
SI23-D5-018G										
SI23-D5-022G										
SI23-D5-030G	172	430	/	255	219	150	150	416.5	7.5	φ4-M5
SI23-T3-037G										

Overall Dimension of Inverter (Steel)

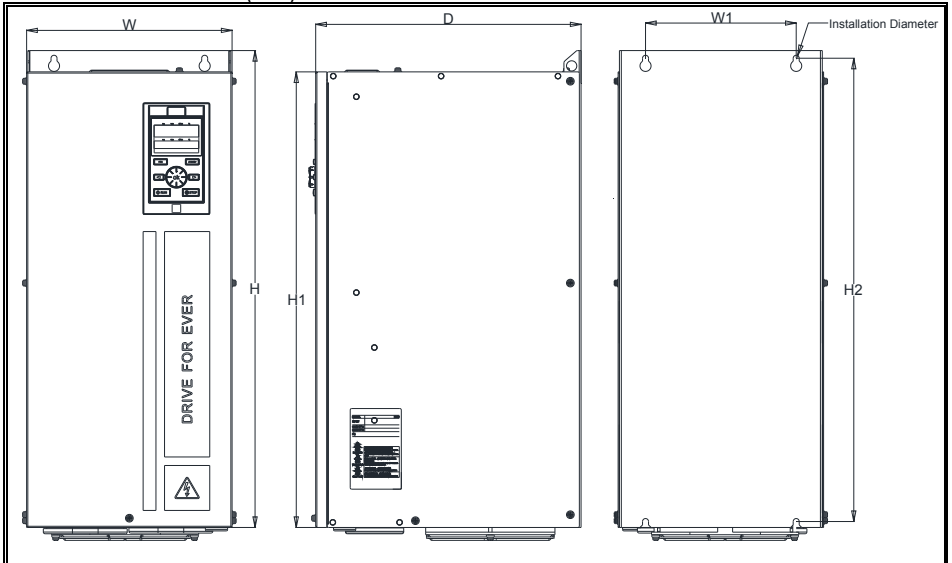

MODEL	Overall Dimension(mm)				Installation		Aperture
	W	H	H1	D	W1	H2	
SI23-T3-045G	240	560	535	310	176	544	φ4-M6
SI23-T3-055G							
SI23-T3-075G							

2.2 Solar Pump Controller Wiring

● Standard Connection Diagram

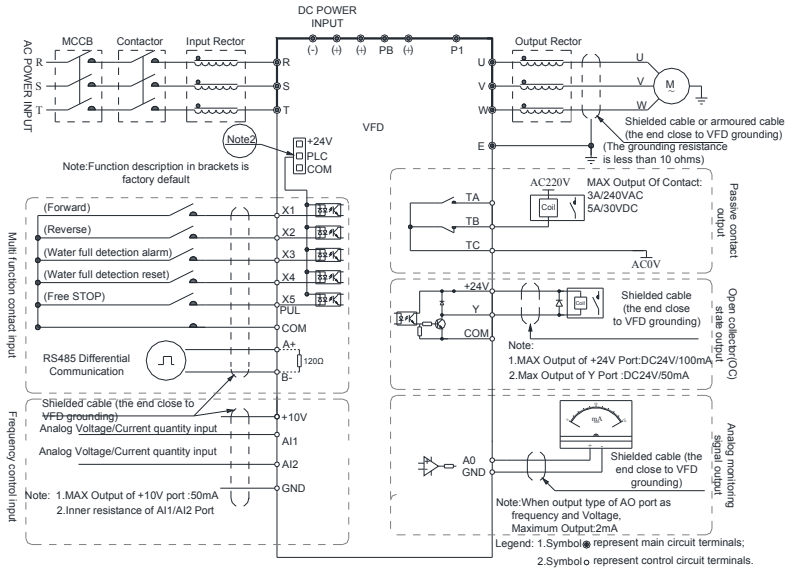

Note: When connect solar panel, both AC input (R, T) and DC input (+, -) is okay, AC input is prefer.

● Auxiliary Terminal Output Capacity

Terminal	Function Definition	Max Output
+10V	10V auxiliary power supply output, constitutes loop with GND.	50mA
A0	Analog monitor output, constitutes loop with GND.	Max output 2mA as frequency, voltage signal
+24V	24V auxiliary power supply output, constitutes loop with COM.	100mA
Y	Collector open circuit output; can set the action-object by program.	DC24V/50mA
TA/TB/TC	Passive connector output; can set the action-object by program.	3A/240VAC

● Function Specification of Switch Terminals

Switch Terminal	Selecting Position	Function Specification
RS485 OFF	<input type="checkbox"/> ON	RS485 Terminal Resistor
AO-F OFF	<input type="checkbox"/> ON	AO-F Output- frequency
AO-I OFF	<input type="checkbox"/> ON	AO-I Output- Current
AO-U OFF	<input type="checkbox"/> ON	AO-U Output- Voltage
AI1 U	<input type="checkbox"/> I	AI1 Input- Current/Voltage
AI2 U	<input type="checkbox"/> I	AI2 Input- Current/Voltage

Chapter 3 Keyboard layout and functions specification

•Keyboard Appearance









•Key function

Key	Name	Function
	Menu key	Enter menu while standby or running. Presses this key to return while modify parameter. While standby or running, press for 1 sec to enter condition monitoring
	Confirm/Shift key	Press to modify parameter while in menu interface. Press again to confirm after modifying; Press this key for 1 Sec to shift digit, and long press to cycle. Each digit flashes three time to shift to next digit.
	Up/down key	Select parameter group in menu interface. Modify parameter in modify state. Modify given frequency, ID given while at standby or monitoring state (While given frequency, PID are set by keyboard and [F4.09] needs to be set.
	Run key	While run/stop is controlled by keyboard, press this key, inverter forward runs, and the indicator is always on. While reverse, the indicator sparks.
	Stop/reset key	Machine stops if press it while run/stop is controlled by keyboard. Its efficiency range is defined by [F4.08]. Inverter resets if press it in fault state (no reset if fault is not





Chapter 4 Fault Diagnosis and Solution









This chapter describes the inverter fault, alerts, and operation of the failure on the inverter, the display information on inverter and countermeasures.

Fault Information and Description in Detail

Keypad display	Fault code	Fault type	Possibility reason	Troubleshooting
	E.LU2	Under voltage at runs	<ul style="list-style-type: none"> ●Power voltage too low ●DC main contactor don't close 	<ul style="list-style-type: none"> ●Check input power to solve ● Ask support
	E.oU1	Over voltage at acceleration	<ul style="list-style-type: none"> ●Power voltage fluctuation over limit ●Too start rotating motor 	<ul style="list-style-type: none"> ● Check power grid ● Restart until motor is stop completely, or set [F1.00] set for 1 or 2
	E.oU2	Over voltage during deceleration	<ul style="list-style-type: none"> ●Deceleration time too small ●The driving load too heavy ●Power voltage fluctuation over limit 	<ul style="list-style-type: none"> ●Prolong deceleration time ●Reduce the load, or select bigger capacitor drive, or connect braking unit ● Check input power
	E.oU3	Overvoltage at constant speed	<ul style="list-style-type: none"> ●The input voltage is too high. ●An external force drives the motor during deceleration 	<ul style="list-style-type: none"> ●Adjust the voltage to normal range. ●Cancel the external force or install the braking resistor.
	E.oU4	Over voltage at stop	<ul style="list-style-type: none"> ●Voltage fluctuate above limit 	<ul style="list-style-type: none"> ● Check the input voltage
	E.oC1	Over current during acceleration	<ul style="list-style-type: none"> ●Acceleration time is too short ●To start rotating motor ●V/F setting not correct or torque boost setting too big ●Solar drive capacitor is too small 	<ul style="list-style-type: none"> ●Prolong acceleration time ●Restart motor when it on still, or set F1.00 for 1 or 2. ● Reset V/f curve or torque boost setting
	E.oC2	Over current during deceleration	<ul style="list-style-type: none"> ●The output circuit is grounded or short circuited. ●Motor auto-tuning is not performed. ●The acceleration time is too short. ●Manual torque boost or V/F 	<ul style="list-style-type: none"> ● Eliminate external faults. ●Perform the motor auto tuning. ● Increase the acceleration time. ● Adjust the manual torque boost or V/F curve. ● Adjust the voltage to normal range.

			<p>curve is not appropriate.</p> <ul style="list-style-type: none"> • The voltage is too low. • The startup operation is performed on the rotating motor. • A sudden load is added during acceleration. • The AC drive model is of too small power class. 	<ul style="list-style-type: none"> • Select rotational speed tracking restart or start the motor after it stops. • Remove the added load. • Select an AC drive of higher power class.
E.oC3	E.oC3	Over current at constant speed	<ul style="list-style-type: none"> • The output circuit is grounded or short circuited. • Motor auto-tuning is not performed. • The voltage is too low. • A sudden load is added during operation. • The AC drive model is of too small power class 	<ul style="list-style-type: none"> • Eliminate external faults. • Perform the motor auto tuning. • Adjust the voltage to normal range. • Remove the added load. • Select an AC drive of higher power class.
E.oL1	E.oL1	Motor overload	<ul style="list-style-type: none"> • Boost torque is too big under VF control • ACC. and DEC. time is too short • Motor parameters setting is improperly • Restart motor which in counter rotate • The grid voltage is too lower • Load is too big or motor block load • AC drive selected is too load 	<ul style="list-style-type: none"> • Reduce boost torque • Increase the ACC./DEC. time • Reset motor parameters • Reduce current limit and adopt speed tracking • Check grid voltage • Check load condition • Change bigger power AC drive
E.oL2	E.oL2	AC drive overload	<ul style="list-style-type: none"> • Boost torque is too big under VF control • ACC. and DEC. time is too short • Motor parameters setting is improperly • Restart motor which in counter rotate • The grid voltage is too lower • Load is too big or motor block load 	<ul style="list-style-type: none"> • Reduce boost torque • increase the ACC./DEC. time • reset motor parameters • Reduce current limit and adopt speed tracking • Too check grid voltage • Too check load • change bigger power AC drive

			<ul style="list-style-type: none"> ●AC drive selected is too load 	
	E.SC	System abnormal	<ul style="list-style-type: none"> ●Deceleration is too short ●Short circuit of solar drive output or phase output short circuit to ground ● Module damage ● EMC interface 	<ul style="list-style-type: none"> ● Prolong acceleration time ● To check peripheral equipment ● Ask to support ● Check the wiring layout, cable ground
	E.oH1	Inverter over-heat	<ul style="list-style-type: none"> ●Temperature is too high. ● Air channel is blocked. ● Fan connection parts is loose. ● Fan is damaged. ●Temperature detection circuit fault 	<ul style="list-style-type: none"> ● Make the environment meet the requirement. ● Clear the air channel. ● Check and reconnect the wire ● Change the same new fan. ● Seek support from factory.
	E.oH2	Rectifier over-heat	<ul style="list-style-type: none"> ●Temperature is too high. ● Air channel is blocked. ● Fan connection parts is loose. ● Fan is damaged. ● Temperature detection circuit fault 	<ul style="list-style-type: none"> ●Make the environment meeting the requirement. ● Clear the air channel. ● Check and reconnect the wire. ● Change the same new fan. ● Seek support from factory.
	E.TE1	Motor static detection fault	<ul style="list-style-type: none"> ● Detection overtime ●Start static detection while motor is running. ● Capacitance difference is too big between motor and inverter. ●Motor parameter setting mistake. 	<ul style="list-style-type: none"> ● Check motor connection wire. ● Detect after motor stopping totally. ● Change inverter model. ● Reset parameter according to nameplate.
	E.TE2	Motor rotation detection fault	<ul style="list-style-type: none"> ●Detect while motor is running. ● Detect with load. ● Detection overtime ●Capacitance difference is too big between motor and inverter. ●Motor parameter setting mistake. 	<ul style="list-style-type: none"> ● Detect after motor stop totally. ● Re-detect without load. ● Check motor connection wire. ● Change inverter model. ● Reset parameter according to nameplate.

	E.EEP	Memory fault	<ul style="list-style-type: none"> ● Electromagnetic disturb in memory period. ● EEPROM damage. 	<ul style="list-style-type: none"> ● Resume load and save. ● Seek support from factory.
	LIFE	Reserved		
	E.oLF	Input phase loss	<ul style="list-style-type: none"> ● 3-phase input power open phase. 	<ul style="list-style-type: none"> ● Check 3-phase power supply and the phase. ● Check 3-phase power supply wiring.
	E.oLF	Output phase loss	<ul style="list-style-type: none"> ● 3-phase output power open phase 	<ul style="list-style-type: none"> ● Check 3-phase output voltage and current. ● Check wiring.
	E.Gnd	Output earth terminal short circuit.	<ul style="list-style-type: none"> ● Check wiring and insulation. 	<ul style="list-style-type: none"> ● Output earth
	E.HAL	Current detection fault	<ul style="list-style-type: none"> ● Detect circuit fault. ● Phase imbalance 	<ul style="list-style-type: none"> ● Seek support from factory ● Check motor and wiring.
	E.PAn	Keyboard connect fault	<ul style="list-style-type: none"> ● Keyboard wire fault. ● Keyboard component damage. 	<ul style="list-style-type: none"> ● Check keyboard wire. ● Seek support from factory.
	Rs485c ommuni cation fault	<ul style="list-style-type: none"> ● Unsuitable baud rate setting. ● Communication wire breaks. ● Communication format does not match upper machine. 	<ul style="list-style-type: none"> ● Set suitable baud rate setting. ● Check communication wire. ● Make sure right communication format. 	<ul style="list-style-type: none"> ● RS485communication fault
	E.CPE	Parameter copy fault	<ul style="list-style-type: none"> ● Parameter copy communication is fault. ● Copy keyboard does not match the inverter. 	<ul style="list-style-type: none"> ● Check wire. ● Select the specified external keyboard model.

Chapter 5 Parameters List

This chapter just provides function parameter table. Specifications refer to AC300 technical manual or inquiry the company.

“●” : Parameter can be changed in the running state.

“○” : Parameter can't be changed in the running state.

“×” : Parameter can be read only.

“-” : Factory setting parameter, only factory can set.

“※” : Parameter is related to the model.

Basic parameters

NO.	Function description	Range of settings and definition		Factory default	Feature	Address
F00.00	Motor control mode	Asynchronous motor control mode: 0: V/F control Synchronous motor control mode: 6: High-performance VC without PG		0	○	0x000
F00.01	Reserved					
F00.02	Run command channel	0: Keyboard control 1: Terminal control	2: RS485 communication control 3: Reserved	0	●	0x002
F00.03	Frequency given source channel A	0: Keyboard number given 1: Reserved 2: Voltage/Current analog AI1 given 3: Voltage/Current analog AI2 given 4: Reserved 5: Terminal pulse PUL given 6: RS485 communication given		0	●	0x003
F00.04	Frequency given source channel B	7: Terminal UP/DW control 8: PID control given 9: Program control (PLC) given 10: Optional card 11: Multi-steps speed given		1	●	0x004
F00.05	Frequency channel B reference source	0: Max. output frequency as reference source 1: Set frequency of channel A as reference source		0	●	0x005
F00.06	Frequency given source selection	0: Channel A 1: Channel B 2: Channel A+Channel B 3: Channel A-Channel B 4: Max. value of Channel A and Channel B 5: Min. value of Channel A and Channel B		0	●	0x006
F00.07	Running Command	LED“0”digit: keyboard command instruction binding LED“00”digit: terminal command instruction binding		0000	●	0x007

	Binding	LED“000”digit: communication command instruction binding LED“0000”digit: optional card command instruction binding 0 : no binding 1 : keyboard number given frequency 2 : Reserved 3 : Voltage/Current analog AI1 given 4 : Voltage/Current analog AI2 given 5 : Reserved 6 : Terminal pulse PUL given 7 : RS485 communication given 8 : Terminal UP/DW control 9 : PID control given A : Program control (PLC) given B : Optional card C : Multi-steps speed given			
F00.08	Keyboard digital setting frequency	0~upper limit	50.00Hz	●	0x008
F00.09	Max frequency	upper limit~600.00Hz	50.00Hz	○	0x009
F00.10	Upper limit frequency source selection	0: Upper limit frequency digital given 1: Reserved 2: Voltage/Current analog AI1 give 3: Voltage/Current analog AI2 given 4: Reserved 5: Terminal pulse PUL given 6: RS485 communication given 7: Optional card	0	●	0x00A
F00.11	Upper frequency limit digital	Lower limit frequency~max frequency	50.00Hz	●	0x00B
F00.12	Lower limit frequency	0.00~upper limit frequency	0.00Hz	●	0x00C
F00.13	Lower limit frequency running mode	0: Stop output, enter into pause running state 1: Run at lower limit frequency	1	○	0x00D
F00.14	ACC time 1	0.01~650.00s	20.00s	※	0x00E
F00.15	DEC time 1	0.01~650.00s	20.00s	※	0x00F
F00.16	Rotary direction selection	LED“0”digit: running direction takes the opposite 0: Direction unchanged 1: Direction takes the opposite LED“00”digit: running direction prohibited 0: Forward and reverse commands are allowed 1: Only FWD command allowed 2: Only REV command allowed LED“000”digit: frequency control direction selection	0000	○	0x010

		0: Invalid 1: Valid LED "0000" digit: reserved				
F00.17	G/P Model Setting	0:G Type	1:P Type	0	●	0x011
F00.18	Reserved					
F00.19	Parameter initialization	0: No action 1: Restore factory default (not restoring motor parameters) 2: Restore factory default (restoring motor parameters) 3: Clear malfunction records		0	○	0x013

Operation Control Parameters Group

NO.	Function description	Range of settings and definition		Factory setting	Feature	Address
F01.10	Stop mode	0:DEC stop	1:Free stop	0	●	0x10A
F01.16	ACC/DEC selection	LED "0" digit: time base selection 0: max frequency 1: fixed frequency 50Hz 2: set frequency LED "00" digit: S ACC/DEC selection 0: Beeline ACC/DEC 1: S Curve ACC/DEC LED "000" digit: reserved LED "0000" digit: reserved		0000	○	0x110
F01.35	Power off restart action selection	0:Invalid	1:Valid	0	○	0x123
F01.36	Power off restart waiting time	0.00~60.00s		0.50s	○	0x124

Switching value terminal parameters

NO.	Function description	Range of setting and definition		Factory setting	Feature	Address
F02.00	Input terminal 1(X1)	0: No function 1:Forward 2:Reverse		1	○	0x200
F02.01	Input terminal 2(X2)			2	○	0x201
F02.02	Input terminal 3(X3)			80	○	0x202
F02.03	Input terminal 4(X4)	80: Water fulfilled detect alarm 81:Water fulfilled detect reset		81	○	0x203
F02.24	Terminal operate protection	0: OFF 1:ON LED "0" digit: Terminal operate protection when abnormal exit LED "00" digit: Jog terminal operate		0111	○	0x218

		protection when abnormal exit LED "000" digit: Operate protection when command channel switch to terminal			
F02.42	Output terminal polarity selection	0: Positive 1: Negative LED "0" digit: Terminal Y LED "00" digit: Relay output 1 LED "000" digit: Extended Y1 terminal LED "0000" digit: Extended Relay output 2	0000	●	0x22A
F02.60	Virtual vX1 terminal function selection	0: No function 1:Forward 2:Reverse 10: Water fulfilled detect alarm 11:Water fulfilled detect reset	0	●	0x238
F02.61	Virtual vX2 terminal function selection		0	●	0x239
F02.62	Virtual vX3 terminal function selection		0	●	0x23A
F02.63	Virtual vX4 terminal function selection		0	●	0x23B
F02.64	vX terminal valid state source	0: internal connection with virtual vYn 1: Connect with physical terminal Xn 2: function code setting valid or not LED "0" digit: virtual vX1 LED "00" digit: virtual vX2 LED "000" digit: virtual vX3 LED "0000" digit: virtual vX4	0	●	0x23C
F02.65	Virtual vX terminal function code setting valid state	0: invalid 1: valid LED "0" digit: virtual vX1 LED "00" digit: virtual vX2 LED "000" digit: virtual vX3 LED "0000" digit: virtual vX4	0	●	0x23D

System parameters

NO.	Function description	Range of settings and definition	Factory setting	Feature	Address
F04.00	Parameter and key lock selections	0: Not locked 1: Function parameter locked 2: Function parameter and key locked (except for RUN/STOP/JOG) 3: All function parameter and key locked	0	●	0x400
F04.01	User password	0~65535	0	●	0x401
F04.05	Parameter copy	0: No function 1: Send inverter parameters to keyboard and save 2: Send keyboard parameters to inverter Remaining value: no operation	0	○	0x405

F04.08	STOP key setting	0: Non-keyboard control mode is invalid 1: Non-keyboard control mode stops according to stop mode 2: Non-keyboard control mode stop according to free stop mode	1	○	0x408
F04.09	UP/DOWN key selection	LED "0" digit: keyboard UN/DOWN key modify selection 0: Invalid 1: Modify frequency setting by key board numbers F00.08 2: Modify PID give setting by key board numbers F11.01 LED "00" digit: power off storage selection 0: No save frequency after power off 1: Save frequency after power off LED "000" digit: action limit 0: Operation stop for adjusting 1: Adjusting only in operation, stop for holding 2: Adjusting in operation, stop for clearing	0011	○	0x409
F04.14	The display content of the first line in running state	LED "0" and "00" digit: display the first group 00~63 LED "000" and "0000" digit: display the second group 00~63	1101	●	0x40E
F04.15	The display content of the first line in running state	Same as above	0402	●	0x40F
F04.16	The display content of the first line in stop state	Same as above	1100	●	0x410
F04.17	The display content of the first line in stop state	Same as above	0402	●	0x411
F04.18	The display content of the second line in running state	Same as above	0402	●	0x412
F04.19	The display content of the second line in running state	Same as above	1210	●	0x413
F04.20	The display content of the second line in stop state	Same as above	0402	●	0x414
F04.21	The display content of the second line in stop state	Same as above	1210	●	0x415

F04.22	Keyboard display item setting	LED "0" digit: output frequency selection 0: Aim frequency 1: Running frequency LED "000" digit: power display dimension 0: Power display percentage (%) 1: Power display kilowatt (KW)	0000	●	0x416
F04.23	Monitor display selection	LED "0" digit: C00.00-C00.39 0: Normal 1: Debugging LED "00" digit: C00.40-C00.69 0: No display 1: Normal display	0000	●	0x417
F04.24	Rotate speed display coefficient	0.0~500.0%	0000	●	0x418
F04.25	Power display coefficient	0.0~500.0%	100.0%	●	0x419
F04.28	Fan control	0: After power on the fan runs 1: Stop associated with temperature, running is rotary 2: Running associated with temperature, stop while the fan stops	1	●	0x41C
F04.32	PWM carrier frequency	0.7~16.0kHz	Model set	※	0x420
F04.33	PWM control mode	LED "0" digit: carrier associated with temperature 0: Temperature independent 1: Temperature dependent LED "00" digit: carrier associated with output frequency 0: not associated 1: associated LED "000" digit: random PWM valid 0: Prohibited 1: Valid LED "0000" digit: PWM modulation mode 0: Only use three-phase modulation 1: Two-phase and three-phase modulation automatically switched	1111	●	0x421

Motor Parameters

NO.	Function description	Range of settings and definition	Factory default	Feature	Address
F05.00	Motor mode	0: Asynchronous motors (AM) 1: Permanent magnet synchronous motors (PM)	0	×	0x500
F05.01	Number of motor poles	2~98	4	○	0x501

F05.02	Motor rated power	0.1~1000.0kW	Model set	※	0x502
F05.03	Motor rated frequency	0.01~max frequency	Model set	※	0x503
F05.04	Motor rated speed	1~65000rpm	Model	※	0x504
F05.05	Motor rated voltage	1~1500V	Model	※	0x505
F05.06	Motor rated current	0.1~3000.0A	Model	※	0x506
F05.07	Asynchronous motor no-load current	0.1~3000.0A	Model set	※	0x507
F05.08	Asynchronous motor stator resistance	0.01~50.00%	Model set	※	0x508
F05.09	Asynchronous motor rotor resistance	0.01~50.00%	Model set	※	0x509
F05.10	Asynchronous motor stator leakage inductance	0.01~50.00%	Model set	※	0x50A
F05.11	Asynchronous motor stator inductance	0.1~2000.0%	Model set	※	0x50B
F05.12	synchronous motor stator resistance	0.01~50.00%	Model set	※	0x50C
F05.13	Synchronous machine d axis inductance	0.01~200.00%	Model set	※	0x50D
F05.14	Synchronous machine q axis inductance	0.01~200.00%	Model set	※	0x50E
F05.15	Synchronous machine back EMF	1~1500V	Model set	※	0x50F
F05.16	Synchronous machine encoder installation angle	0.0°~360.0°	Model set	※	0x510
F05.20	Motor parameters self-adjustment selections	0: No operation 1: Rotary type self-tuning 2: Static type self-tuning 3: Stator resistance self-tuning	0	○	0x514
F05.21	Synchronous machine poles searching function	LED "0" digit: closed-loop vector 0: OFF 1: ON 2: On, only operate firstly when electrify LED "00" digit: open-loop vector 0: OFF 1: ON 2: ON, only operate firstly when electrify	0010	○	0x515

Motor VC Parameters

NO.	Function description	Range of settings and definition	Factory default	Feature	Address
-----	----------------------	----------------------------------	-----------------	---------	---------

F06.00	ASR(speed loop) proportional gain 1	0.01~100.00	10.00	●	0x600
F06.01	ASR integral time 1	0.000~6.000s	0.200s	●	0x601
F06.02	ASR filter time1	0.0~100.0ms	0.0ms	●	0x602
F06.03	ASR switch frequency 1	0.00 ~ Max frequency	0.00Hz	●	0x603
F06.04	ASR (speed loop) proportional gain 2	0.01~100.00	10.00	●	0x604
F06.05	ASR (speed loop) integral time 2	0.000~6.000s	0.200s	●	0x605
F06.06	ASR filter time 2	0.0~100.0ms	0.0ms	●	0x606
F06.07	ASR switch frequency 2	0.00 ~ Max frequency	5.00Hz	●	0x607
F06.08	Electric motor torque limit	0.0~250.0%	180.0%	●	0x608
F06.09	Power generation torque limit	0.0~250.0%	180.0%	●	0x609
F06.10	Current loop D-axis proportional gain	0.001~4.000	1.000	●	0x60A
F06.11	Current loop D-axis integral gain	0.001~4.000	1.000	●	0x60B
F06.12	Current loop Q-axis proportional gain	0.001~4.000	1.000	●	0x60C
F06.13	Current loop Q-axis integral gain	0.001~4.000	1.000	●	0x60D
F06.15	Vector control motor slip compensation	0.0~250.0%	100.0%	●	0x60F
F06.16	Vector control start torque	0.0~250.0%			
F06.17	Reserved				
F06.18	Position compensation control	0:OFF 1:ON	10.0%	○	0x613
F06.19	compensation gain	0.0~250.0%	0.1%	○	0x614
F06.20	compensation limit	0.0~100.0%	10.0%	○	0x615
F06.21	compensation effective range	0.0~100.0%	100.0%	○	0x616
F06.22	Over excitation braking gain	0.0~500.0%	100.0%	○	0x617
F06.23	Over excitation braking amplitude limit	0.0~250.0%	0	○	0x618
F06.24	Vector control energy saving function	0:OFF 1:ON	50.0%	●	0x619
F06.25	Energy saving control gain	0.0~80.0%	0.010s	●	0x61A
F06.26	Energy saving control low-pass filter	0.000~6.000s	200.0%	●	0x61B
F06.27	Motor constant power area power limit	0.0~250.0%	60.0%	○	0x61C
F06.28	Motor weak magnetic current upper limit	0.0~250.0%	10.0%	●	0x61D

F06.29	Motor weak magnetic feed forward gain	0.0~200.0%	10.0%	●	0x61E
F06.30	Motor weak magnetic gain	0.0~500.0%	10.0%	●	0x620
F06.32	MTPA gain	0.0~500.0%	100.0%	●	0x621
F06.33	MTPA filter time	0.0~100.0ms	1.0ms	●	0x621
F06.34	Reserved				
F06.35	Low frequency pull in current	0.0~100.0%	10.0%	●	0x623
F06.36	High frequency pull in current	0.0~100.0%	10.0%	●	0x624
F06.37	Frequency of current pulled in	0.0~100.0%	10.0%	●	0x625

Protection and Malfunction Parameter Group

NO.	Function description	Range of settings and definition	Factory default	Feature	Address
F10.06	Bus over voltage suppression function	LED"0" digit: Over voltage suppression 0: Invalid 1: Valid in DEC 2: Valid both in ACC/DEC LED"00" digit: Over-excitation control 0: off 1: on LED"000"/"0000": Reserved	0012	○	0xA06
F10.07	Bus over voltage suppression point	110.0~150.0%	128.0%	※	0xA07
F10.08	Bus over voltage suppression gain	0.0~500.0%	100.0%	●	0xA08
F10.14	Short-circuit detection after power on	LED "0" digit: Earth short-circuit detection after power on 0: off 1: on LED"00" digit: Fan short-circuit detection after power 0: off 1: on	11	○	0xA0E
F10.15	phase missing protection	LED"0" digit: Output phase missing protection 0: off 1: on LED"00" digit: Input phase missing protection 0: off 1: Open Alarm 2: Open Fault(STOP VFD) LED"000" /"0000" digit: Reserved	0021	○	0xA0F
F10.16	Motor overload protection curve coefficient	0.0~250.0%	100.0%	○	0xA10
F10.38	Malfunction self-recovery times	0~5	0	○	0xA26
F10.39	Malfunction self-recovery interval time	0.1~100.0s	1.0s	○	0xA27

Communication Control Function Parameter Group

NO.	Function description	Range of setting and definition	Factory default	Feature	Address
-----	----------------------	---------------------------------	-----------------	---------	---------

F13.00	Main-slave machine selection	LED "0" digit: Modbus main-slave selection 0: Slave machine 1: Main machine LED "00" /"000" /"0000" digit: reserved		0000	○	0xD00
F13.01	485 communication address	1~247		1	○	0xD01
F13.02	Communication baud rate selection	LED"0" digit:485 communication 0:1200 bps 1:2400 bps 2:4800 bps 3:9600 bps 4:19200 bps 5:38400 bps LED "00" /"000" /"0000" digit: reserved		0003	○	0xD02
F13.03	Modbus data format	0: (N,8,1)format 1: (E,8,1) format 2: (O,8,1) format	3: (N,8,2) format 4: (E,8,2) format 5: (O,8,2) format	0	○	0xD03
F13.10	RS485 Communication port configuration	0: Modbus communication 1: serial port communication		0	●	0xD0A

★ Photovoltaic Pump Special Parameters

Function code	Function name	Setting range and definition	Default setting	property	Comm. Add
F14.00	Solar pump drive control mode	0 : Variable frequency control mode 1 : CVT mode for solar 2 : MPPT mode for solar	2	○	0xE00
F14.01	Running control mode	0 : Stop 1 : Running 2 : Sleep 3 : Low speed protection 4 : Dry run protection 5 : Over current protection 6 : Minimum power protection	Read only		0xE01
F14.02	VOC voltage (display)	0.0 ~ 999.9V	Read only		0xE02
F14.03	CVT target voltage	70.0 ~ 95.0%	81.0%	●	0xE03
F14.04	MPPT upper limit voltage	20.0 ~ 200.0%	100.0%	●	0xE04
F14.05	MPPT lower limit voltage	20.0 ~ 200.0%	50.0%	●	0xE05

F14.06	Frequency adjusting gain	0.1 ~ 500.0%	10.0% (AM) 40.0% (PMSM)	●	0xE06
F14.07	MPPT search interval	0.1 ~ 100.0	1.0s	●	0xE07
F14.08	MPPT regulating gain	0 ~ 9999	100	●	0xE08
F14.09	Quick-drop frequency gain	0 ~ 20	2	●	0xE09
F14.10	Frequency adjusting filter time	0.001 ~ 2.000 s	0.001	●	0xE0A
F14.11	Go to sleep mode voltage	0 ~ 1000V	0V	●	0xE0B
F14.12	Wake up restore voltage	0 ~ 1000V	400V	●	0xE0C
F14.13	Sleeping stop restore waiting time	0.0 ~ 3000.0s	10.0s	●	0xE0D
F14.14	Low speed protection detect frequency	0.00 ~ 300.00Hz	10.00Hz	●	0xE0E
F14.15	Low speed protection detect time	0.0 ~ 3000.0s	10.0s	●	0xE0F
F14.16	Low speed protection restore working time	0.0 ~ 3000.0s	10.0s	●	0xE10
F14.17	Dry run protection detect current	0.0 ~ 999.9A	0.0A	●	0xE11
F14.18	Dry run protection detect time	0.0 ~ 3000.0s	10.0s	●	0xE12
F14.19	Dry run auto restore working time	0.0 ~ 3000.0s	10.0s	●	0xE13
F14.20	Over current point setting	0.0 ~ 999.9A	0.0A	●	0xE14
F14.21	Over current protection detect time	0.0 ~ 3000.0s	10.0s	●	0xE15
F14.22	Over current protection auto restore working time	0.0 ~ 3000.0s	10.0s	●	0xE16

F14.23	Input minimum power protection power point setting	0.00 ~ 650.00kw	0.00kw	●	0xE17
F14.24	Minimum power protection detect time	0.0 ~ 3000.0s	10.0s	●	0xE18
F14.25	Minimum power protection auto restore working time	0.0 ~ 3000.0s	10.0s	●	0xE19
F14.26	Fault alarm restore mode	0 : Auto reset;1 : Reset by manual LED0 : Low speed protection LED1 : Dry run LED2 : Over current protection LED3: Minimum power protection	0000	●	0xE1A
F14.27	Water fulfilled detect time	0.0s ~ 3000.0s	10.0s	●	0xE1B
F14.28	Water fulfilled restore time	0.0s ~ 3000.0s	10.0s	●	0xE1C
F14.29	reserve			●	0xE1D
F14.30	DC current revise offset	0.00 ~ 99.99A	0.01A	●	0xE1E
F14.31	DC current revise proportion gain	0.0 ~ 999.9%	100.0%	●	0xE1F
F14.32	Power curve point 0	0.00 ~ 99.99kw	0.50kw	●	0xE20
F14.33	Power curve point 1	0.00 ~ 99.99kw	1.00kw	●	0xE21
F14.34	Power curve point 2	0.00 ~ 99.99kw	1.50kw	●	0xE22
F14.35	Power curve point 3	0.00 ~ 99.99kw	2.00kw	●	0xE23
F14.36	Power curve point 4	0.00 ~ 99.99kw	2.50kw	●	0xE24
F14.37	Flow curve point 0	0.0 ~ 999.9m3/h	0.0 m3/h	●	0xE25
F14.38	Flow curve point 1	0.0 ~ 999.9m3/h	5.0 m3/h	●	0xE26
F14.39	Flow curve point 2	0.0 ~ 999.9m3/h	10.0 m3/h	●	0xE27
F14.40	Flow curve point 3	0.0 ~ 999.9m3/h	15.0 m3/h	●	0xE28
F14.41	Flow curve point 4	0.0 ~ 999.9m3/h	20.0 m3/h	●	0xE29
F14.42	Flow calculating revise offset	0.0 ~ 999.9m3	0.0m3	●	0xE30
F14.43	Flow calculating revise gain	0.0 ~ 999.9%	100.0%	●	0xE31

F14.44	Power per day/ generated power per day reset period	0.0 ~ 24.0h	7.0h	●	0xE32
F14.45	Reserved				
F14.46	Photovoltaic pump function selection 1	0 : Invalid 1 : Valid LED0 : Constant torque frequency limit selection LED1 : Reserved LED2 : Voltage rising update Voc voltage LED3: Fast frequency falling function	1100H	●	0xE34
F14.47	Fast frequency falling threshold	3.0% ~ 15.0%	5.0%	●	0xE35
F14.48	Constant torque frequency limit coefficient	80.0% ~ 150.0%	100.0%	●	0xE36
F14.49	Sudden voltage increase threshold	0.0% ~ 20.0%	5.0%	●	0xE37
F14.50	Reserved				

★ Photovoltaic Pump Special Monitor Parameters

Function code	Function name	Setting range and definition	Default setting	property	Comm. Add
C02.00	Frequency reference	0.01Hz	Read only		2300H
C02.01	Output frequency	0.01Hz	Read only		2301H
C02.02	Output current	0.1A	Read only		2302H
C02.04	Output voltage	0.1V	Read only		2304H
C02.10	Output power	0.01kw	Read only		230AH
C02.11	DC bus voltage	0.1V	Read only		230BH
C02.12	Module temperature 1	0. 1℃	Read only		230CH
C02.30	DC current	0.01A	Read only		231EH
C02.31	Flow speed	0.1 m3/h	Read only		231FH

C02.32	Voc voltage	0.1 V	Read only		2320H
C02.33	Flow per day	0.1 m3	Read only		2321H
C02.34	Cumulative total flow(low position)	0.1m3	Read only		2322H
C02.35	Cumulative total flow(high position)	0.1km3	Read only		2323H
C02.36	Generated power per day	0.01kwh	Read only		2324H
C02.37	Cumulative total generated power (low position)	0.01kwh	Read only		2325H
C02.38	Cumulative total generated power (high position)	0.1Mwh	Read only		2326H

Input terminals ON/OFF status illustration

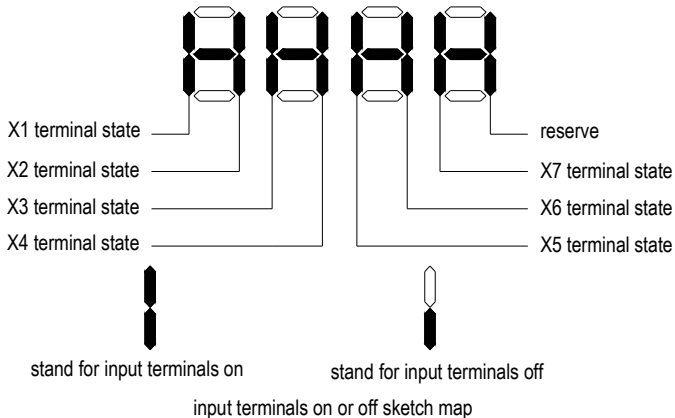

Chapter 6 Operation Guidance

6.1 Asynchronous Motor Pump Drive Operation Guidance

1) Wiring:

- a. Confirmed the solar pump drive if mating with motor.
- b. Correctly connecting "+""-" of solar panel to corresponding "+""-" pole of inverter or R, T wiring terminals. Otherwise it will cause inverter damage.
- c. Connect motor wire and ground wire to corresponding U, V, W, E terminals.

2). Parameters setting and trial run:

- a. Set F0.00 to 0, F0.02 for 0, and F0.09, F0.11, F0.14, F0.15 parameters setting according to application site.
- b. Set motor(pump) parameters according to nameplate of pump.
- c. Set solar pump MPPT mode F14.001 for 1 or 2.
- d. Press FWD button for trail running, and confirm the motor running direction.

3) Common problems

- a, Q : Well-lit conditions, the pump is running, but the water is very small.
A : Check if the pump motor direction is reversed.
- b, Q : Well-lit conditions, the drive is in standby mode 0.00Hz.
A : Check F14.01, observe what protection status is the drive in currently, check whether the parameters set is reasonable.
- c, Q : DC current is incorrectly displayed.
A : Adjust F14.30, F14.31 for calibration.
- d, Q : Well-lit conditions, frequency severe beating during operation.
A : Reasonably adjust F14.06 value, the adjustment is recommended to be in the vicinity of the default, too big or too small will cause frequency oscillation.

6.2 Synchronous Motor Pump Drive Operation Guidance

1) Wiring:

- a. Confirm if the solar pump drive matches with the motor.
- b. Connecting "+""-" of solar panel to corresponding "+""-" of inverter or R, T wiring terminals. Otherwise it will cause inverter damage.
- c. Connect motor wire and ground wire to corresponding U, V, W, E terminals.

2) Parameters setting and trial run:

- a) . Set F0.00 to 6, F0.02 for 0, and F0.09=100.00, F0.11=100.00; F0.14, F0.15 can be set according to demand.
- b). Set motor (pump) parameters according to nameplate of pump. Then Set F5.20 for 1, the keypad will show T-00, press FWD to start motor auto tuning. This process takes about three minutes;

Note: 1. If you can disconnect the motor and load, self-learning would be better;

2. The self-learning need to be done with enough sunshine and when the solar panels can provide enough energy.

- c). Set solar pump MPPT mode F14.00 for 1 or 2.
- d). Press FWD button for trail running, and confirm the motor running direction.

3) Common problems and solutions

a, Q : Well-lit conditions, the pump is running, but the water is very small.

A : Check if the pump motor direction is reversed.

b, Q : Well-lit conditions, the drive is in standby mode 0.00Hz.

A : Check F14.01, observe what protection status is the drive in currently, check whether the parameters set is reasonable.

c, Q : DC current is incorrectly displayed.

A : Adjust F14.30, F14.31 for calibration.

d, Q : Well-lit conditions, frequency severe beating during operation.

A : Reasonably adjust F14.06 value, the adjustment is recommended to be in the vicinity of the default, too big or too small will cause frequency oscillation.

e, Q : The current fluctuation is huge when the pump is running.

A : Check C02.39, adjusting the value of F5.15, so the C02.39 displays the value from 0-10.

6.3 PV Water Pump Features

A. Sleep Function

During the photovoltaic pump operation, the inverter will go into sleep state when the DC voltage provided by solar panels is lower than FE.11 (sleep voltage threshold) due to objective factors, while the keyboard warning "A.LPn"; when DC voltage provided by solar panels rises back to F14.12 (sleep recovery voltage) point, start timing and after FE.13 (sleep shutdown waiting time), the drive starts running.

B. Low-frequency Protection Function

During the operation of the photovoltaic pump, for some reason, the output frequency is lower than F14.14 (low frequency detection frequency), and after F14.15 (under frequency detection time) time, enters into the standby protection state, while the keyboard warning "A.LFr"; after entering into the standby protection state and after F14.16 (frequency protection automatic recovery) time, automatically resume to running state.

C. Dry Run Protection

During the operation of the photovoltaic pump, for some reason, the output current is less than F14.17 (dry protection current detection), and after F14.18 (dry protection detection time) time, enters into standby protection state, while the keyboard warning "A.LuT"; after entering into the standby protection state and after F14.19 (dry protection automatic recovery)time, automatically resume to running state.

D. Over-current Protection

During the operation of the photovoltaic pump, for some reason, the output current is greater than F14.20(over current point setting), and after F14.21 (over current protection detect) time, enters into standby protection state, while the keyboard warning "A.oLd "; after entering into the standby protection state and after F14.22 (over current protection auto restore working)time, automatically resume to running state.

E. Minimum Power Protection

During the operation of the photovoltaic pump, for some reason, the output power is less than F14.23(minimum power protection value), and after F14.24 (minimum power protection detection time) time, enters into standby protection state, while the keyboard warning "A.LPr"; after entering into the standby protection state and after F14.25 (minimum power automatic

recovery)time, automatically resume to running state.

F. Full Water Protection

Detect the water full alarm and low water level through two X terminals, realizing automatic level control. Wherein F14.27 is the water overflow protection detection time and F14.28 is full water protection exit time, and X 3 terminal is defined as full solar water detection alarm, and X4 terminal is defined as full solar water detection alarm reset, the warning signal is shown as "A.Ful".

G. Alarm Recovery Mode: 0: automatic recovery; 1: manual recovery

This option is for low frequency protection, dry protection, over-current protection, minimum power function; you can select the alarm restoration by F14.26. When you select 0 for automatic recovery, during fault warning displaying, you can also press the "RESET" button to stop operation; during fault warning displaying, you can press the "RESET" button to manually clear, you can also press "RESET" button to achieve stop operation.

H. PQ Curve Function

This model provides a self-defined PQ curve for users to set up five groups of PQ corresponding points according to the pump cases, to achieve real-time traffic speed, daily flow, cumulative flow, generating capacity, cumulative electricity consumption; of which by default, daily flow and generating capacity are calculated based on 7h in a day.

I. Status Check

When the photovoltaic pump is running, you can check F14.01 to confirm the current operating status.